

EN-770e

17 inch Flat CRT Color Monitor

User's Manual

by Envision Peripherals, Inc.
www.ENVISIONmonitor.com.com

Before operating your monitor, please read this manual thoroughly.



FCC Statement

This equipment has been tested and found to comply with the limits for a Class B digital device, pursuant to Part 15 of the FCC Rules. These limits are designed to provide reasonable protection against harmful interference in a residential installation. This equipment generates, uses and can radiate radio frequency energy, and if not installed and used in accordance with the instructions, may cause harmful interference to radio communications. However, there is no guarantee that interference will not occur in a particular installation. If this equipment does cause harmful interference to radio or television reception, which can be determined by turning the equipment off and on, the user is encouraged to try to correct the interference by one or more of the following measures:

1. Reorient or relocate the receiving antenna.
2. Increase the separation between the equipment and receiver.
3. Connect the equipment into an outlet on a circuit different from that to which the receiver is connected.
4. Consult the dealer or an experienced radio/TV technician for help.

Notice

1. The changes or modifications not expressly approved by the party responsible for compliance could void the user's authority to operate the equipment.
2. Shielded interface cables and AC power cord, if any, must be used in order to comply with the emission limits.
3. The manufacturer is not responsible for any radio or TV interference caused by unauthorized modification to this equipment. It is the responsibility of the user to correct such interference.

As an ENERGY STAR® Partner, Envision Peripherals, Inc. has determined that this product meets the ENERGY STAR® guidelines for energy efficiency.

Warning

To prevent fire or shock hazard, do not expose the monitor to rain or moisture. Dangerously high voltage is present inside the monitor. Do not open the cabinet. Refer servicing to qualified personnel only.

Precautions

- Do not use the monitor near water, e.g. near a bathtub, washbowl, kitchen sink, laundry tub, swimming pool or in a wet basement.
- Do not place the monitor on an unstable cart, stand, or table. If the monitor falls, it can injure a person and cause serious damage to the appliance. Use only a cart or stand recommended by the manufacturer or sold with the monitor. If you mount the monitor on a wall or shelf, use a mounting kit approved by the manufacturer and follow the kit instructions.
- Slots and openings in the back and bottom of the cabinet are provided for ventilation. To ensure reliable operation of the monitor and to protect it from overheating, be sure these openings are not blocked or covered. Do not place the monitor on a bed, sofa, rug, or similar surface. Do not place the monitor near or over a radiator or heat register. Do not place the monitor in a bookcase or cabinet unless proper ventilation is provided.
- The monitor should be operated only with the type of power source indicated on the label. If you are not sure of the type of power supplied to your home, consult your dealer or local power company.
- The monitor is equipped with a three-pronged grounded plug, a plug with a third (grounding) pin. As a safety feature, this plug will only fit into a grounded power outlet. If your outlet does not accommodate the three-wire plug, have an electrician install the correct outlet, or use an adapter to ground the appliance safely. Do not defeat the safety purpose of the grounded plug.
- Unplug the unit during a lightning storm or when it will not be used for long periods of time. This will protect the monitor from damage due to power surges.
- Do not overload power strips and extension cords. Overloading can result in fire or electric shock.
- Never push any object into the slot on the monitor cabinet. It could short circuit parts causing a fire or electric shock. Never spill liquids on the monitor.
- Do not attempt to service the monitor yourself; opening or removing covers can expose you to dangerous voltage and other hazards. Please refer all servicing to qualified service personnel.
- To ensure satisfactory operation, use the monitor only with UL-listed computers which have appropriately configured receptacles marked between 100 - 240 V AC, Min. 3.5A.
- The wall socket should be installed near the equipment and should be easily accessible.

General Notes

- Do not install the monitor near heat sources such as radiators or air ducts.
- Do not place monitor in direct sunlight or in areas with excessive dust, mechanical vibration or shock.
- Save the original shipping carton and packing materials in case you need to ship your monitor. Be sure to repackage your monitor as it was originally packed at the factory.
- Periodically clean your monitor with a soft cloth. Stubborn stains may be removed with a cloth lightly dampened with a mild detergent solution. **Never use strong solvents such as thinners, benzene, or abrasive cleaners, since these will damage the cabinet.** Always unplug the monitor before cleaning it.

Using the Right Power Cord

The supplied power cord is a NEMA 5-15 style plug. It is UL-listed and CSA labeled for 125 volts AC.

If the monitor will be connected to your computer's power outlet, use a minimum No. 18 AWG, type SJT or SVT three conductors cord with one end terminating with a male grounded plug, rated 10A, 250V, CEE-22. The other end must terminate with a molded-on type connector body, rated 10A, 250V, having standard CEE-22 female configuration.

General Features:

- 17" (43.2 cm) Color Monitor
- Crisp, Clear Display for Windows
- Supports Resolutions up to 1280 X 1024 pixels @60Hz
- EPA ENERGY STAR®

Package Contents

The box that your monitor was shipped in should have included the following items:

1. EN-770e Color Monitor
2. Power Cord
3. Quick Start Guide
4. Booklet
(containing Warranty and Safety information)

Installing & Removing the Base

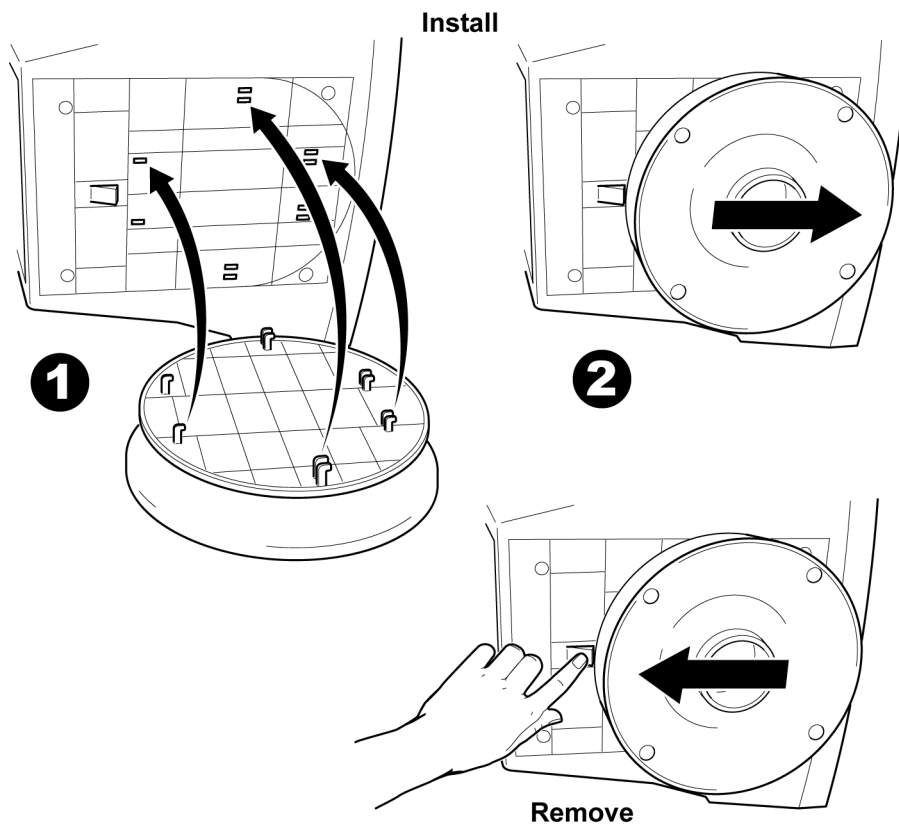

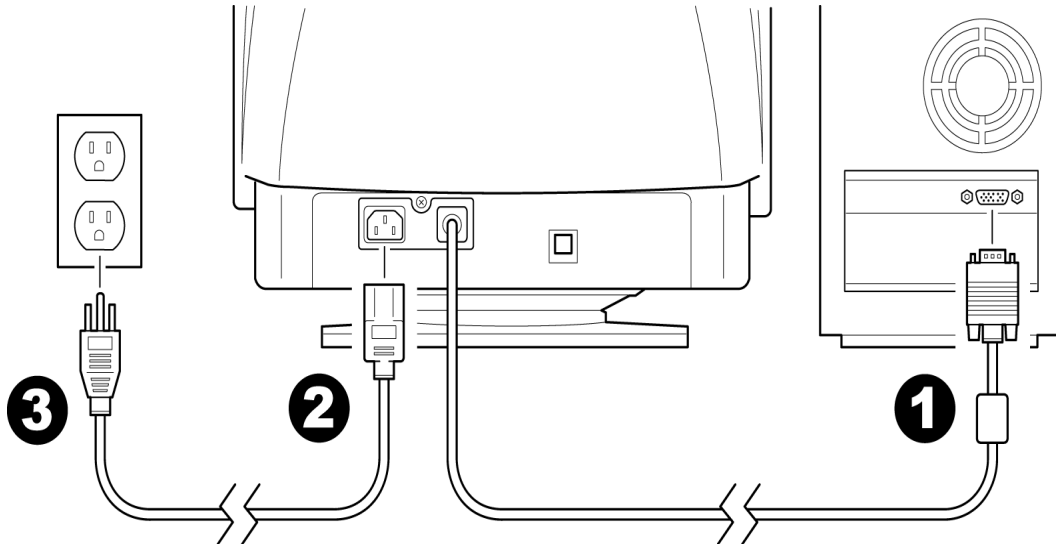
Connecting the Wires Using the Power Cord Supplied

1. Connect the built-in video cable into the 15-pin connector on the back of your computer and tighten the two screws.
2. Connect the power cord into your monitor's power input socket.
3. Plug the other end of the power cord into a grounded AC outlet or UL-approved power strip.

Caution: Make sure the power cord is the correct type that is required in your area. This monitor has a universal power supply that allows operation in either 100/120V AC or 220/240V AC voltage areas (no user adjustment is required).

If the AC outlet is not grounded (with three holes), install the proper grounding adapter (not supplied).

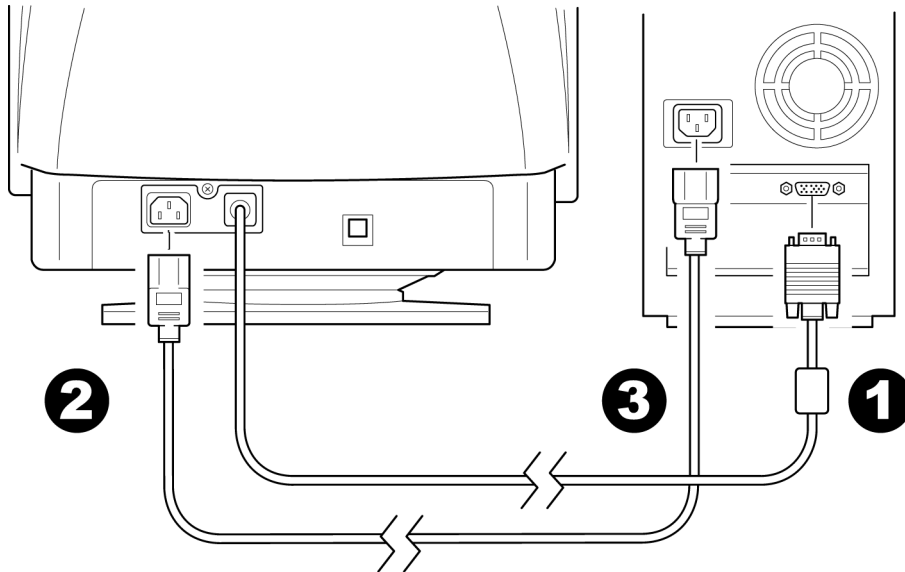
Connecting the Wires Using An Optional Power Cord (Not Supplied)

The power cord supplied with your monitor can only be connected to a grounded electrical wall socket or power strip.

If you wish to connect your monitor to a power supply using the power input socket on the back of your computer, you must purchase a power cord with CEE-22 terminated connectors (see illustration above).

Follow these steps:

1. Connect the built-in video cable into the 15-pin connector on the back of your computer and tighten the two screws.
2. Connect the power cord into your monitor's power input socket.
3. Plug the other end of the power cord into the power output socket on your PC.

Front Panel Buttons

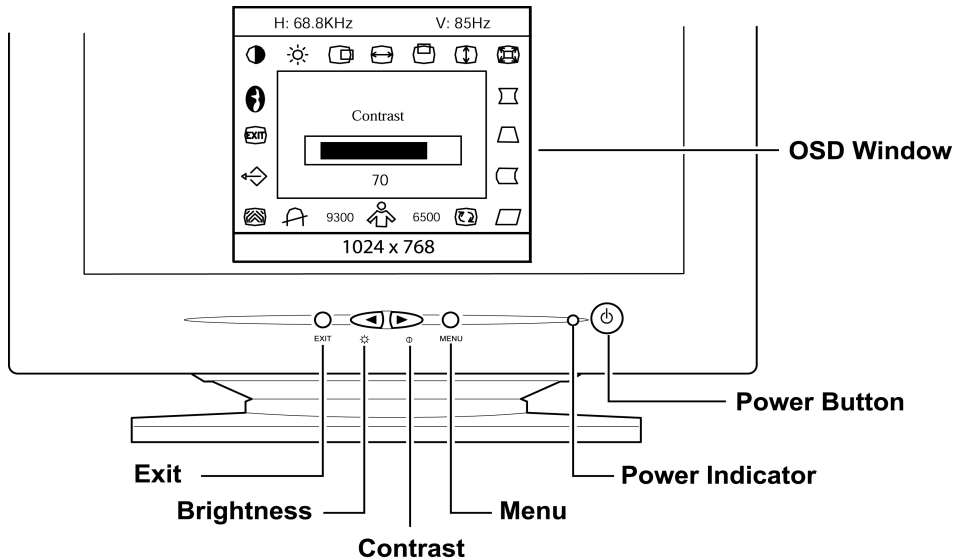



 **Exit:** Press this button to save changes and close the OSD window.

 **Brightness:** Press this button to adjust the picture's brightness. If the OSD window is open, this button allows you to move within the window and select desired functions.

 **Contrast:** Press this button to adjust the picture's contrast. If the OSD window is open, this button allows you to move within the window and select desired functions.

 **MENU:** Press this button to open the OSD window or select a highlighted function.

 **Power Indicator:** A green light indicates that the monitor is on. An orange light indicates that the monitor is in Off mode.

 **Power:** Press this button to turn the monitor on or off. The power indicator will light up.





On-screen Display (OSD): Press the **MENU** button to open the OSD window and adjust settings on your monitor. (See next page.)

Adjusting the OSD Settings

 **Language**
Adjusts the language selection

 **Contrast**
Adjusts the picture's contrast

 **Brightness**
Adjusts the picture's brightness

 **H-Center**
Adjusts the horizontal position of the picture

 **H-Size**
Adjusts the horizontal size of the picture

 **V-Center**
Adjusts the vertical position of the picture

 **V-Size**
Adjusts the vertical size of the picture

 **Zoom**
Adjusts the vertical and horizontal size of the picture simultaneously

 **Pincushion**
Adjusts the picture until the edges neither bulge out nor pull in.

 **Trapezoid**
Adjusts the top and bottom of the picture until the sides are parallel

 **Pin Balance**
Adjusts to compensate for the pincushion unbalance

 **Parallelogram**
Shifts the top and bottom of the picture left or right until the sides are vertical

 **Rotation**
Rotates the entire picture

6500 **Color Temp**
Adjusts the color temperature to 6500°K (x=0.313, y=0.329)

 **User Color (Red/Blue)**
Adjusts the Red/Blue Gain controls to obtain optimum whiteness level

9300 **Color Temp**
Adjusts the color temperature to 9300°K (x=0.283, y=0.297)

 **Degauss**
Adjusts color impurity caused by monitor movement or magnetic field build-up inside the monitor

 **Moire Reduce**
Reduces interference that appears as ripples or wave patterns

 **Recall**
Restores the monitor to factory settings.

 **Exit**
Saves changes and closes the OSD window.

1. Press the **MENU** button to open the OSD window.
2. Press the < or > buttons until the desired function is highlighted.
3. Press **MENU** to open the function's window.
4. Press the < or > buttons to change the settings of the function.

5. To save and exit, press the **EXIT** icon or leave the monitor alone for 10 seconds. If you want to adjust any other function, repeat steps 2-4.

Note: When the OSD window is open, the input signal timing settings appear at the top.
H: stands for horizontal frequency and
V: stands for vertical frequency.

Plug & Play DDC1/2B Feature

This monitor is equipped with VESA DDC1/2B capabilities according to the VESA DDC STANDARD. It allows the monitor to inform the host system of its identity and, depending on the level of DDC used, communicate additional information about its display capabilities. The communication channel is defined in two levels, DDC1 and DDC2B.

The DDC1 is a unidirectional data channel from the display to the host that continuously transmits EDID information. The DDC2B is a bidirectional data channel based on the I²C protocol. The host can request EDID information over the DDC2B.

Windows INF Driver File

Most computers will automatically configure your monitor to work with your computer. For optimal viewing of your monitor, download the Envision monitor driver.

Follow these steps:

1. Go to www.ENVISIONmonitor.com
2. Click on SERVICES & SUPPORT to open the drivers web page.
3. Follow the directions on the web page to download and install the driver on your computer.

Or go to www.ENVISIONmonitor.com/support/drivers.asp to directly access the driver web page.

Problem	Possible Solution
Power LED is not ON	<ul style="list-style-type: none"> • Make sure the power button is ON. • Make sure the power cord is properly connected to a grounded power outlet and to the monitor.
No Plug & Play	<ul style="list-style-type: none"> • Confirm that your computer is Plug & Play compatible. • Confirm that your video card is Plug & Play compatible. • Inspect the video cable and make sure that none of the pins are bent. • Make sure the Envision monitor drivers are installed (ENVISION monitor drivers are available at: www.ENVISIONmonitor.com)
Picture is fuzzy	<ul style="list-style-type: none"> • Adjust the Contrast and Brightness settings.
Picture bounces or a wave pattern is present in the picture	<ul style="list-style-type: none"> • Move electrical devices away from the monitor. They may be causing electrical interference.
Power LED is ON (green or orange light is ON) but there is no video or picture.	<ul style="list-style-type: none"> • Press a key on the keyboard or wiggle the mouse to re-activate the monitor. • Make sure the video cable is properly connected to the computer. • Inspect the video cable and make sure none of the pins are bent. • Make sure your computer is operating correctly by pressing the CAPS LOCK key and observing whether the CAPS LOCK light turns ON or OFF.
Missing one of the primary colors (RED, GREEN, or BLUE)	<ul style="list-style-type: none"> • Inspect the video cable and make sure that none of the pins are bent. • Make sure the video cable is properly connected to the computer.
Screen image is not centered or sized properly	<ul style="list-style-type: none"> • Adjust the Horizontal, Vertical or Zoom settings in the OSD window.
Picture has color defects (white does not look white)	<ul style="list-style-type: none"> • Adjust the User Color setting in the OSD window.

Specifications

CRT	Size	17.0" (43.2 cm) 11.4" (29 mm) neck
		0.21mm(H), 0.25mm(D) dot pitch
		90 degree deflec- tion
Viewable image size		16.0" (40.6 cm) diagonal
Preset Display area		11.8" (300 mm) X 9.1" (230 mm)
Dot Clock		110 MHz
Maximum Resolution		1280 x 1024 pixels
Plug & Play		VESA DDC1/2B TM

Input	Video	Red, Green, Blue Analog Interface
	Separate Sync.	H/V TTL
	H/V Sync.	Positive/Negative
	H-Frequency	30 kHz - 72 kHz
	V-Frequency	50 Hz -160 Hz
Input Video Sig- nal		Analog: 0.7 Vpp, 75 OHM, Positive
Power Source		Universal AC 100 - 240 V 50/60 Hz
Factory Preset Mode		6
User Programmable Mode		10
EPA ENERGY STAR®		Yes
Power Consumption (Maximum)		120 Watts
Regulatory Compliance		UL, CSA, FDA, FCC, TÜV/GS, MPRII, Windows® XP Logo

Specifications (continued)

Environmental Considerations	Operating Temp: 32° to 104°F (0° to 40°C) ambient
	Operating Humidity: 10% to 90%
Signal Cable	Attached Mini D-sub 15 Male

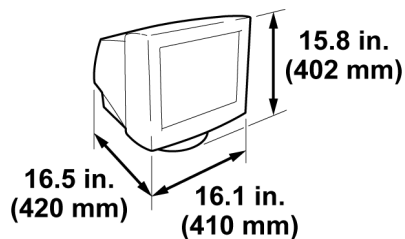

Optimal Viewing Mode: 1024 x 768 x 85 Hz

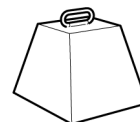

**37.5 lbs.
(17.0 Kg)**

Factory Preset Timing Table

Standard	Resolution (in pixels)	Horizontal Frequency	Vertical Frequency
VGA	720 x 400	31.5KHz	70 Hz
	640 x 480	31.5KHz	60 Hz
VESA / 85	640 x 480	43.3KHz	85Hz
	800 x 600	53.7KHz	85Hz
	1024 x 768	68.7KHz	85Hz
VESA / 60	1280 x 1024	64.0 kHz	60 Hz

Connector Pin Assignment

Pin Number	Description	Pin Number	Description
1	Red	9	NC
2	Green	10	Ground
3	Blue	11	Monitor Ground
4	Ground	12	DDC-Serial Data
5	Ground	13	H-Sync
6	R-Ground	14	V-Sync
7	G-Ground	15	DDC-Serial Clock
8	B-Ground		

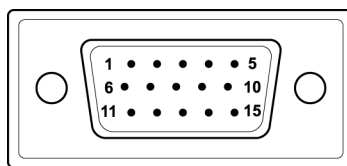

**15-Pin Color Display
Signal Cable**